

## Operating Instructions for model AL-T750.3 High Frequency High Voltage Output Transformer

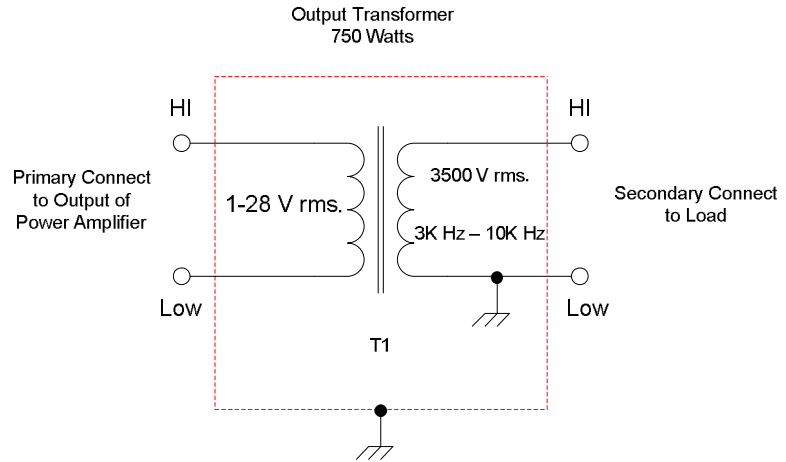

This model AL-T750.3 high frequency high voltage output transformer was manufactured to meet the following basic specifications.

Primary Volts:	28 V rms.
Secondary Volts:	3500 V rms.
Output Power:	750 watts
Frequency Range:	3K Hz to 10K Hz

Additional characteristics of the transformer are:

Dimensions:	10" X 8" X 6"
Weight:	20 lbs

When operating this high voltage transformer, a secure earth ground connection must be made to the cabinet of the transformer. Mishandling of high voltage transformers can lead to accidental death. Thus, this transformer should only be operated by qualified personnel with high voltage knowledge.

The operating frequency range of the above output transformer needs to be strictly confined within the specified frequency range of 3K Hz to 10K Hz.

When operating this HFHV transformer, it is strongly recommended that the amplitude be increased slowly from zero volts while monitoring the output voltage with a high frequency high voltage probe and an oscilloscope. The output voltage must not exceed 20% of rated maximum output voltage. Over-voltage can damage the transformer.