

## Data Sheets and Operating Instructions Model AL-T250.1 Output Transformer

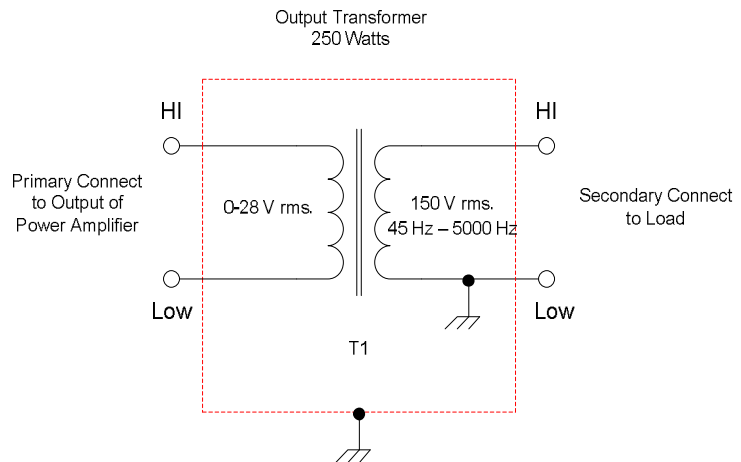

This model AL-T250.1 output transformer was manufactured to meet the following basic specifications.

Primary Volts:	28 V rms.
Secondary Volts:	150 V rms.
Output Power:	250 watts
Frequency Range:	45 Hz to 5000 Hz

Additional characteristics of the transformer are:

Dimensions:	6" X 5" X 4"
Weight:	8 LBs

When operating this output transformer, a secure earth ground connection must be made to the cabinet of the transformer. Mishandling of high voltage transformers can lead to accidental death. Thus, this transformer should only be operated by qualified personnel with electronic knowledge.

The operating frequency range of the above output transformer needs to be strictly confined within the specified frequency range of 45 Hz to 5000 Hz.

When operating this output transformer, it is strongly recommended that the amplitude be increased slowly from zero volts while monitoring the output voltage with an oscilloscope. The output voltage must not exceed 120% of rated maximum output voltage. Over-voltage can damage the transformer.