

MODEL AL-50-CR-H/S AC CONSTANT CURRENT SOURCE

Constant current sources provide a steady output current independent of the load and input power line with variations. Usage of these constant sources include generating magnetic fields, testing and qualifying products such as circuit breakers, relays, transformers, watt-hour meters, etc.

The model AL-50-CR-H/S constant current source includes a full complimentary linear transconductance power amplifier, a 60 Hz (50 Hz and 400 Hz can be specified also) built-in oscillator and an output transformer. It outputs an adjustable sine wave AC constant current. The output frequency of this model is fixed and defaulted at 60 Hz (or 50 Hz / 400 Hz).

Specifications of model AL-50-CR-H/S Constant Current Power Source

Output:

Output Power: 50 watts continuous
Output Current: 0 – 10 A rms. @ 5 V compliance volts
0 – 25 A rms. @ 2 V compliance volts
Output Frequency: 60 Hz (+/- 0.2Hz) fixed; (50 and 400 Hz can be specified as defaulted output frequencies also.)
Output Waveform: sine wave
Current Regulation: 1% load regulation or better;
0.1% line regulation or better
Output Distortion: 1% T.H.D.
Hum and Noise: -60dB below full output
Output Terminal: Phoenix Contacts connector on back panel
Thermal Protection: auto-reset thermostat prevents heat damage
Short Circuit Protection: Input line circuit breaker
Power Factor Range: +0.7 to -0.7 for full power;
to zero @ reduced power

Input Power:

Power Efficiency: 45%
Input Power: 120 V AC 60 Hz (Defaulted)
Input Line Current Req.: 2 A @ 120 V AC

Other Specifications:

Dimensions: 3.5"H X 19"W X 17"D
Weight: 25 lbs
Cooling Method: Air force fan on back panel
Operating Temp Range: -20 to 140 deg F
Storage Temp Range: -40 to 170 deg F

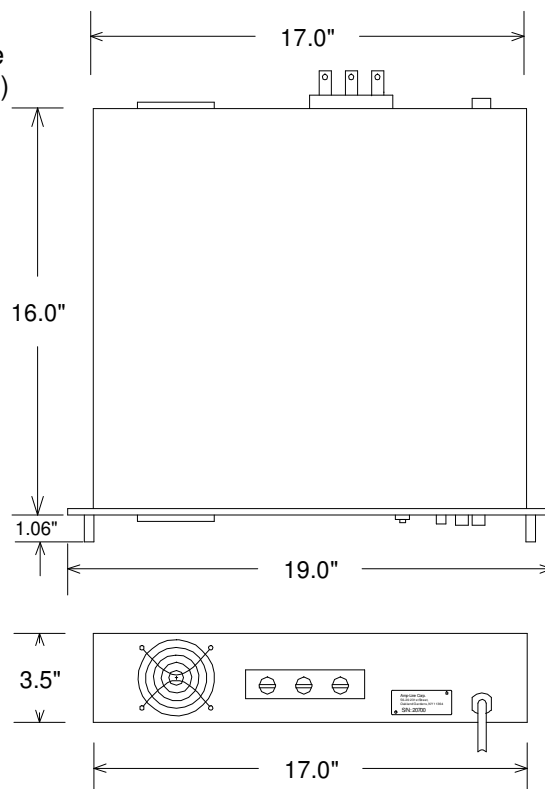

Note: 1. Custom output current range can be specified at no additional cost.
2. Custom output frequency (less than 2k Hz) can be specified at no additional cost.

Purchase Options (at additional cost):

- 0-10V DC Controller
(Output current amplitude will be controlled by a 0-10V DC control signal. Control signal input BNC connector locates on front panel.)
- 0-10V DC Output Monitoring Circuit
(Output terminals are 5-way binding posts on front panel.)
- Dual output frequencies are available at request.
- Square wave output is available at request.
- Higher output frequency (2K Hz to 20K Hz) is available at request.

Amp-Line Corp.

3 Amethyst Court
West Nyack, NY 10994
Tel: (845)-623-3288 Fax: (845)-623-3369

E-mail: sales@amp-line.com
Web site: www.amp-line.com