

## MODEL AL-50-CR-H/S AC CONSTANT CURRENT SOURCES

Constant current sources/amplifiers provide steady output current despite of variations in loads and input power lines. Usage of these constant sources includes generating magnetic fields, testing and qualifying products such as circuit breakers, relays, transformers, watt-hour meters, etc.

The model AL-50-CR-H/S constant current sources output adjustable sine wave AC constant current. The output frequency of this model is defaulted at 60 Hz. 50 Hz, 400 Hz and other frequencies within the frequency range of 47 Hz – 2K Hz are available at request. The standard output ranges of this model are listed below. Custom output range(s) can be specified at no additional cost.

### Specifications of model AL-50-CR-H/S Constant Current Power Sources

#### Output:

Output Power:	50 watts continuous
Output Current:	0 – 10 A rms. @ 5 V compliance voltage 0 – 25 A rms. @ 2 V compliance voltage
Output Frequency:	60 Hz (+/- 0.2Hz) fixed; (50 and 400 Hz can be specified as default output frequencies also.)
Output Waveform:	sine wave
Current Regulation:	1% load regulation or better; 0.1% line regulation or better
Output Distortion:	1% T.H.D.
Hum and Noise:	-65dB below full output
Output Terminals:	Panduit copper lugs on back panel (They can be put on the front if requested.)
Thermal Protection:	Auto-reset thermostat prevents heat damage
Fault Protection:	Input line circuit breaker

#### Input Power:

Power Efficiency:	45% max.
Input Power:	120 V AC 60 Hz (Default); 230 V AC 60 Hz (at request)
Input Line Current Req.:	2 A @ 120 V AC (or 1 A @ 230 V AC)

#### Other Specifications:

Dimensions:	5.25"H X 19"W X 16"D
Weight:	30 lbs
Cooling Method:	Air force fan on back panel
Operating Temp Range:	20 to 140 deg F
Storage Temp Range:	-40 to 170 deg F

#### Dimension Drawing

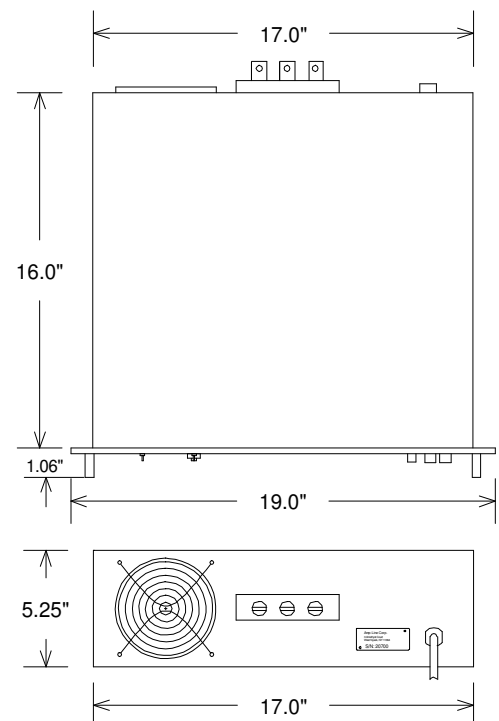

#### Purchase Options (at additional cost):

1. Purchase Option 101: 0-10 V DC Remote Control Option (Add "-C0/10" suffix at the end of the model number.)
2. Purchase Option 102: RS232 Remote Control Option (Add "-RS232" suffix to model number.)
3. Purchase Option 103: GPIB Remote Control Option (Add "-GPIB" suffix to model number.)
4. Purchase Option 104: 0-10V DC Output Monitoring Circuit (Add "OM0/10" suffix to model number.)
5. Purchase Option 105: Dual output frequencies are available at request. (Add "-Ff1/f2" suffix to model number.)
6. Purchase Option 106: Square wave output is available at request. (Add "-SQ" suffix to model number.)
7. Purchase Option 107: Higher Output Frequency (than 2K Hz) (Add "-XXKHz" suffix to model number.)