

# MODEL AL-750-HF-A HIGH FREQUENCY POWER AMPLIFIER

The model AL-750-HF-A power amplifier is a wide-band, full complimentary class AB linear amplifier. The output impedance is zero because of the negative feedback. Our customers use the amplifiers for plasma excitation, induction heating, EMC testing, EMI testing, magnetic field generation and testing products such as Helmholtz coils, piezo elements, inductors, capacitors. Our power ratings are for continuous duty at full power with +0.7 to -0.7 power factor.

## Specifications of model AL-750-HF-A Power Amplifier

### Output:

Output Power:	750 watts
Output Volts:	0-28 V rms. adjustable (Optional external output transformers to other volts are available at additional charge.)
Frequency Range:	5 Hz to 800K Hz
Max. Output Current:	26.8 A rms.
Output Distortion:	1% T.H.D. @ midband, 2% @ 200K Hz
Hum and Noise:	-60dB below full output
Output Impedance:	Zero ohm (50 ohm matching at request)
Output Volt Meter:	2% front panel analog Meter
Short Circuit Protection:	Input line circuit breaker
Thermal Protection:	Auto-reset thermostat prevents heat damage
Power Factor Range:	+0.7 to -0.7 for full power; to zero @ reduced power

### Input Signal:

Input Signal Req.:	0-2 V rms.
Input Impedance:	5K ohm
Input Waveform:	Sine Wave (Square and triangle waveforms will work at less bandwidth.)

### Input Power:

Power Efficiency:	45% max.
Input Power Req.:	120 V AC 60 Hz (Default) or 230 V AC, 60 Hz
Input Line Ampere Req.:	17 A @ 120 V AC; 8.5 A @ 230 V AC

### Other Specifications:

Dimensions:	7.0"H X 19"W X 23"D
Weight:	75 lbs
Cooling Method:	Internal fans (Intake-front; Output-rear)
Operating Temp Range:	-20 to 140 deg F
Storage Temp Range:	-40 to 170 deg F

### Options:

#### 1. DC Coupling

Normally our power amplifiers are AC coupled and usually supplied by us with output transformers to provide the voltage ranges specified by the customer. However, if specified the power amplifier amplifiers can be DC coupled (add "-DC" to the end of part number). As a result, the frequency response of the power amplifiers will be DC to 800K Hz at 0-28 V rms.

#### 2. Output Transformers

Our output transformers can go up to 10K V rms. or 800 A, depending on desired frequency range. Consult factory for information on our standard or custom output transformers.

DIMENSION DRAWING

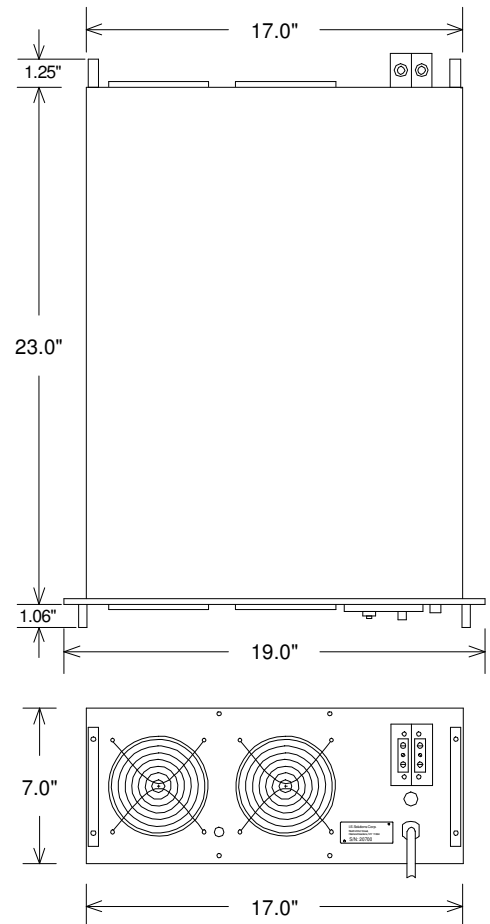

## Amp-Line Corp.

3 Amethyst Court  
West Nyack, NY 10994  
Tel: (845)-623-3288 Fax: (845)-623-3369

E-mail: [sales@amp-line.com](mailto:sales@amp-line.com)  
Web site: [www.amp-line.com](http://www.amp-line.com)